

AS A266 seismic profile can be applied with many different types of finishes (granite, marble, ceramic etc.) at different thicknesses. During the seismic based contractions , pop-up mechanism ascends the center plate without damaging the finish placed on it and gets back to origin after activity is over. Thermal expansion or contraction doesn't activate the center plate. They are ideal for the places with heavy pedestrian traffic and high earthquake risk.

It differs from AS A250 with snap-on stainless steel cap, 65 mm height, and multipartite middle bowl system.

- Application Areas** : Indoor & Outdoor / Floor
- Ideal for** : Airports, Shopping Malls, Residences, Hospitals, Hotels, Commercial and Public Buildings etc.
- Material** : Mill Finish Aluminum (Anodizing optional), Stainless Steel, Galvanized Steel
- Aluminum Alloy** : 6063 AA-USA / EN AW 6063
- Optional Supplies** : PE Backing Rod, PU Mastic, Fire Barrier, Waterproof EPDM membrane

SEISMIC

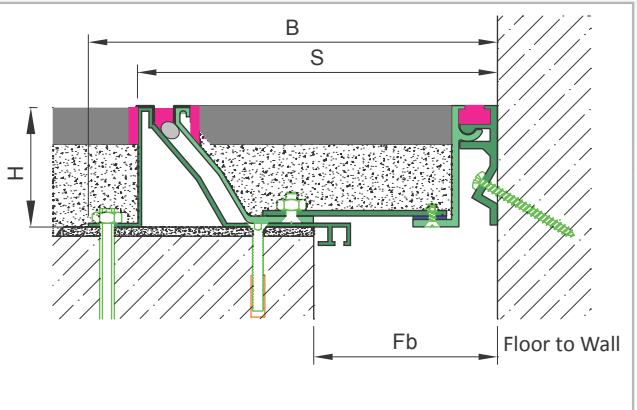
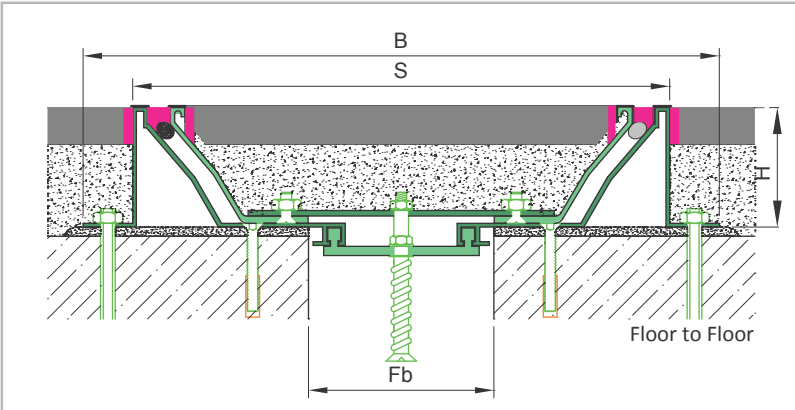
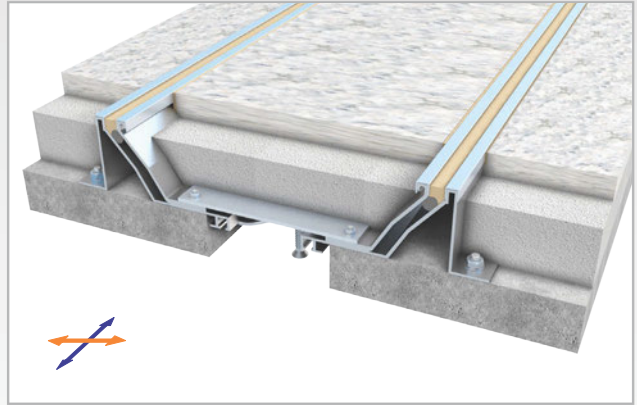
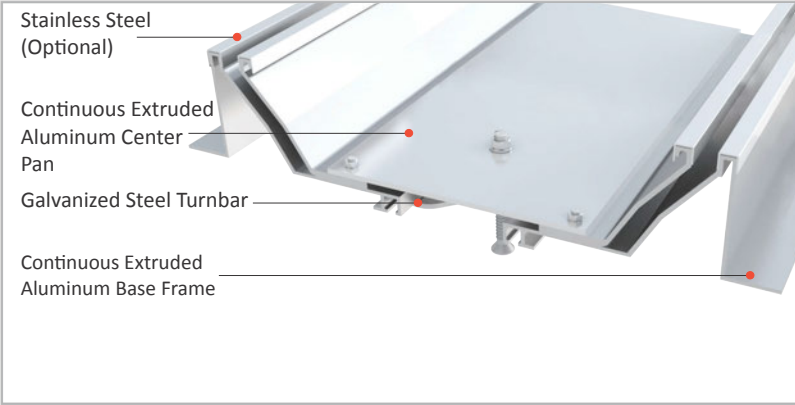

* Visuals are representative and the profile configuration may differ depending on the characteristics requested.

| LOCATION | MODEL | GAP (Fb) mm | HEIGHT (H) MM | OVERALL WIDTH (B) mm | VISIBLE WIDTH (S) mm | MOVEMENT (W) mm | LOAD CAPACITY | STANDARD LENGTH (mt) |
|----------------|-------------|-------------|---------------|----------------------|----------------------|-----------------|---------------|----------------------|
| Floor to Floor | AS A266-100 | 100 | 65 | 350 | 296 | +30 /-45 | | 3 |
| | AS A266-150 | 150 | 65 | 400 | 346 | +50 /-40 | | 3 |
| | AS A266-200 | 200 | 65 | 450 | 396 | +60 /-40 | | 3 |
| | AS A266-300 | 300 | 65 | 550 | 496 | +70 /-40 | | 3 |

Note: Please ask for different sizes

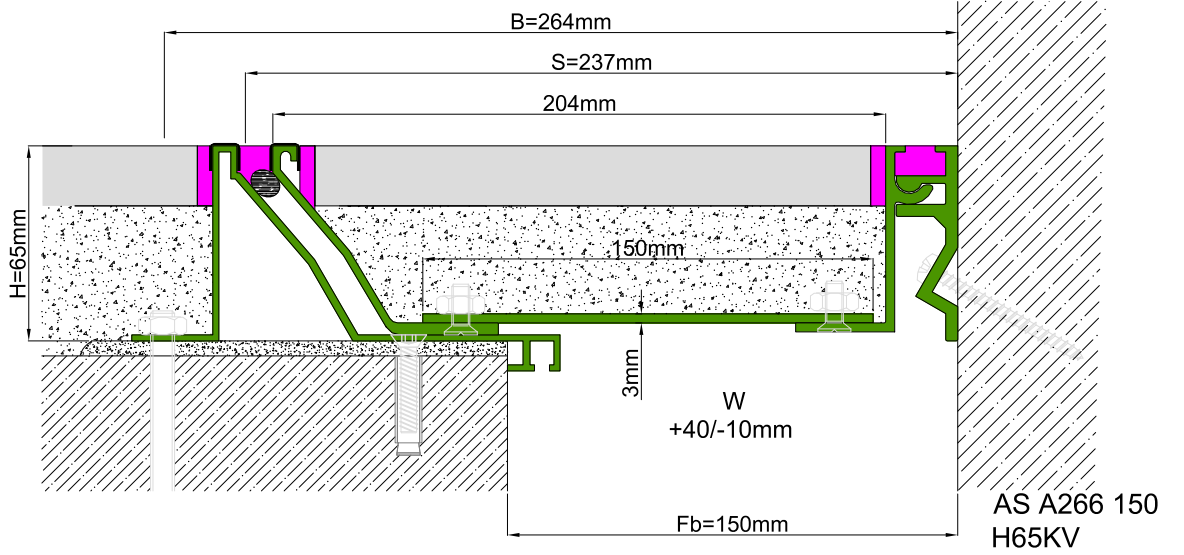
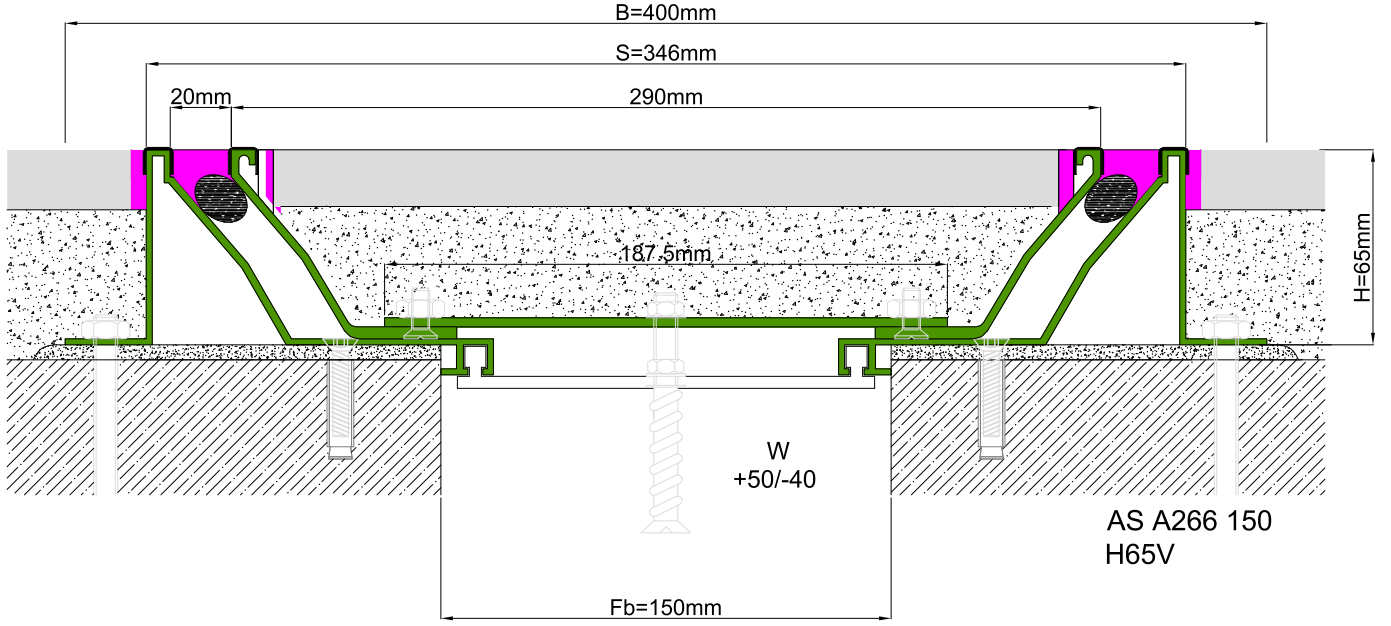

| Profil No Profile Number | AS A266 150 | AS A266 150K |
|---|---|--------------|
| Fb (mm) | 150 | 150 |
| H (mm) yaklaşık approx. | 65 | 65 |
| W± (mm) yaklaşık approx. | +50/-40 | +40/-10 |
| Renk Color | Alüminyum: Natürel Aluminum: Natural | |
| Malzeme Material | Alüminyum Aluminum | |
| Standart Uzunluk Standard Length | 3 | |
| Yükleme Kapasitesi Load-Bearing Capacity |  | |